

19.5 x M10 SLOT BUSH  
(FOR M10 SCREWS ONLY)  
19.5 x M14 BUSH FOR  
SWIVEL HEAD

1  
446-4-2 SPIDER  
MASTER COPY  
SCALE: 1:3

2  
TYPICAL FIXING OPTIONS  
SCALE: NTS

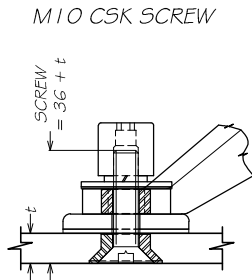

M10 CSK SCREW  
M10 AGA NUT  
M10 SPRING WASHER  
30 x 2 x M10 FLAT WASHER  
30 x 0.8 x M10 FIBRE GASKET  
19.5 x 10.5 x 9.5 BUSH FOR SPIDER PALM  
445 SPIDER PALM  
50 x 6mm DISC  
50 x 10.5 x 0.8 FIBRE GASKET  
M10 CSK BUSH, TO SUIT GLASS THICKNESS

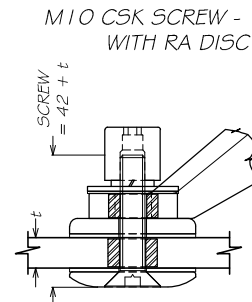

M10 CSK SCREW -  
WITH RA DISC  
M10 AGA NUT  
M10 SPRING WASHER  
30 x 2 x M10 FLAT WASHER  
30 x 0.8 x M10 FIBRE GASKET  
19.5 x 10.5 x 9.5 BUSH FOR SPIDER PALM  
445 SPIDER PALM  
50 x 6mm DISC  
50 x 10.5 x 0.8 FIBRE GASKET  
19.5 x 10.5 BUSH, TO SUIT GLASS THICKNESS  
50 x 10.5 x 0.8 FIBRE GASKET  
50 x 6 x M10 RA DISC

HOLE DETAILS FOR TOUGHENED GLASS

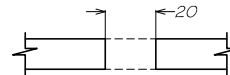
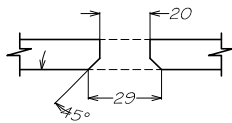

HOLE DETAILS FOR TOUGHENED LAMINATED GLASS  
(THESE ARE PROJECT SPECIFIC. REFER TO MFG FOR DETAILS)

AUSTVISION



METRO FRAMELESS GLASS SYSTEMS  
Unit 0/35 Maurice Road, Penrose, Auckland  
PO Box 112 186, Penrose, Auckland  
P: +64 9 622 2643  
F: +64 9 622 2648  
www.metroglasstech.co.nz

446 SPIDER SERIES  
CATALOGUE DRAWING  
446-4-2  
WITH SCREW FIXINGS

Architect: -  
Contractor: -

ISS:	REV	ISSUED	DWN BY	CHKD	DESCRIPTION
01	A	02/09/14	RS	WF	ISSUED FOR CATALOGUE
Scale:	1:3				
Dwg No.:	01				

THIS DOCUMENT IS THE PROPERTY OF METRO GLASSTECH. IT MUST NOT BE COPIED NOR THE CONTENTS PASSED ON TO ANY THIRD PARTY WITHOUT THE CONSENT OF THE COMPANY.

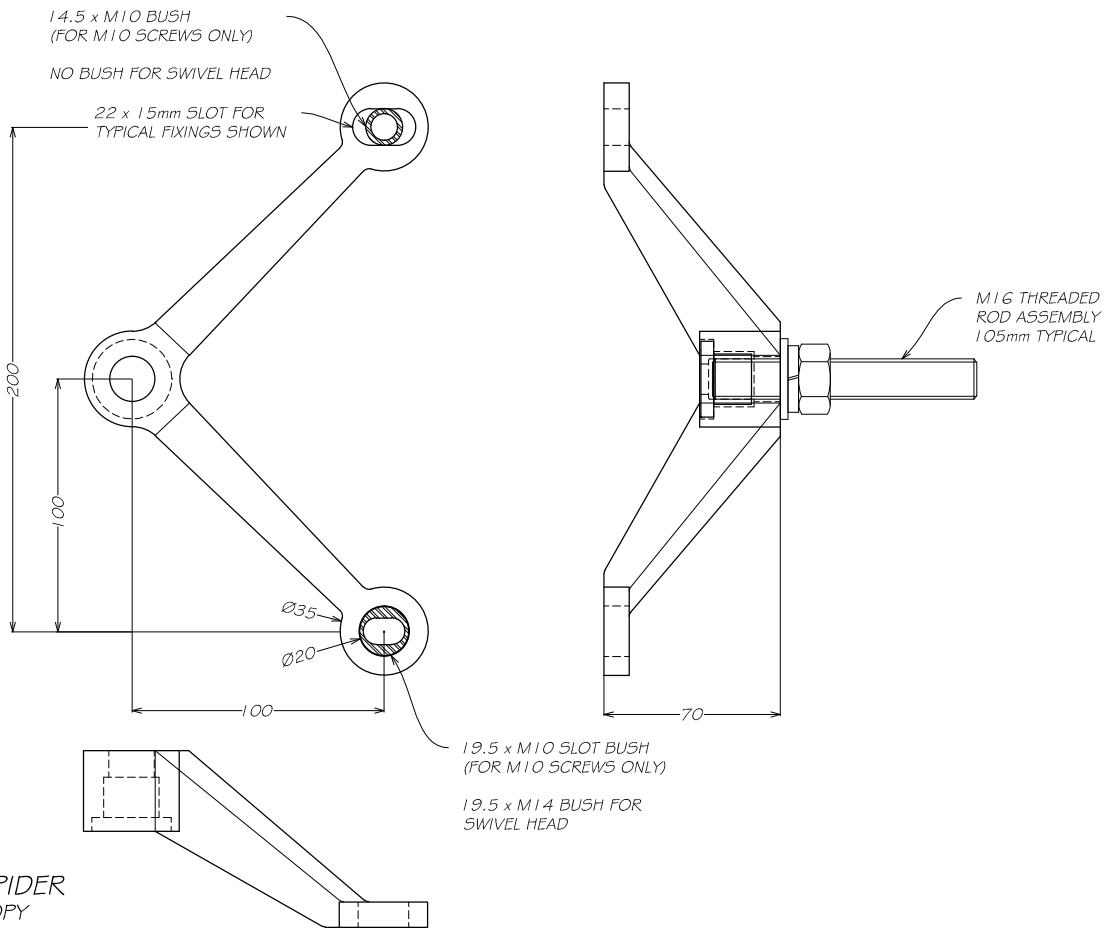

1  
446-4-2 SPIDER  
MASTER COPY  
SCALE: 1:3

2  
TYPICAL FIXING OPTIONS  
CONTINUED  
SCALE: NTS

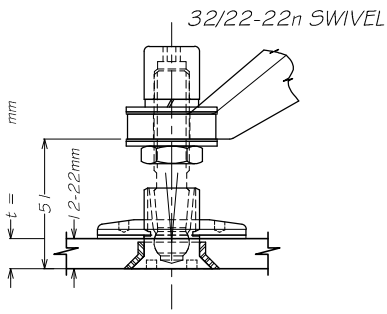

- M14 AGA NUT
- M14 SPRING WASHER
- 35 x 2 x M14 FLAT WASHER
- 35 x 0.8 x M14 FIBRE GASKET
- POSSIBLE 19.5 x 14.5 x 9.5 BUSH FOR SPIDER PALM
- 445 SPIDER PALM
- 35 x 0.8 x M14 FIBRE GASKET
- 35 x 2 x M14 FLAT WASHER
- M14 NUT
- 32/22/22n SPIDER FITTING, INCLUDES BUSH TO SUIT GLASS THICKNESS

60/22-22n SWIVEL

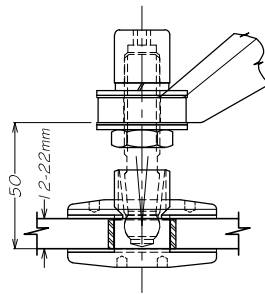

- M14 AGA NUT
- M14 SPRING WASHER
- 35 x 2 x M14 FLAT WASHER
- 35 x 0.8 x M14 FIBRE GASKET
- POSSIBLE 19.5 x 14.5 x 9.5 BUSH FOR SPIDER PALM
- 445 SPIDER PALM
- 35 x 0.8 x M14 FIBRE GASKET
- 35 x 2 x M14 FLAT WASHER
- M14 NUT
- 60/22/22n SPIDER FITTING, INCLUDES BUSH TO SUIT GLASS THICKNESS

60/22-42n SWIVEL

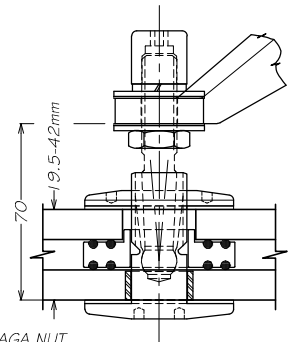

- M14 AGA NUT
- M14 SPRING WASHER
- 35 x 2 x M14 FLAT WASHER
- 35 x 0.8 x M14 FIBRE GASKET
- POSSIBLE 19.5 x 14.5 x 9.5 BUSH FOR SPIDER PALM
- 445 SPIDER PALM
- 35 x 0.8 x M14 FIBRE GASKET
- 35 x 2 x M14 FLAT WASHER
- M14 NUT
- 60/22/42n SPIDER FITTING, INCLUDES BUSH TO SUIT GLASS THICKNESS
- IGU SPACER - 60 x 12mm DISC/ 60 x 1/2" DISC

HOLE DETAILS FOR TOUGHENED GLASS

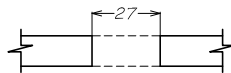
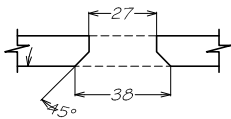

HOLE DETAILS FOR TOUGHENED LAMINATED GLASS  
(THESE ARE PROJECT SPECIFIC. REFER TO MFG FOR DETAILS)

HOLE DETAILS FOR INSULATED GLASS

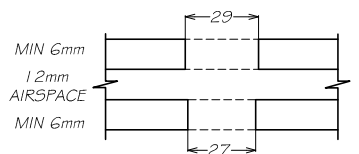

AUSTVISION



METRO FRAMELESS GLASS SYSTEMS  
Unit 0/35 Maurice Road, Penrose, Auckland  
PO Box 112 186, Penrose, Auckland  
P: +64 9 622 2643  
F: +64 9 622 2648  
www.metroglasstech.co.nz

446 SPIDER SERIES  
CATALOGUE DRAWING  
446-4-2  
WITH SWIVEL FIXINGS

Architect: -  
Contractor: -

REV	ISSUED	OWN BY	CHKD	DESCRIPTION	
1	A	0205/1/4	RS	WF	ISSUED FOR CATALOGUE
Scale:	1:3				
Dwg No.:	01				

THIS DOCUMENT IS THE PROPERTY OF METRO GLASSTECH. IT MUST NOT BE COPIED NOR THE CONTENTS PASSED ON TO ANY THIRD PARTY WITHOUT THE CONSENT OF THE COMPANY.