

19.5 x M10 SLOT BUSH
(FOR M10 SCREWS ONLY)

19.5 x M14 BUSH FOR
SWIVEL HEAD

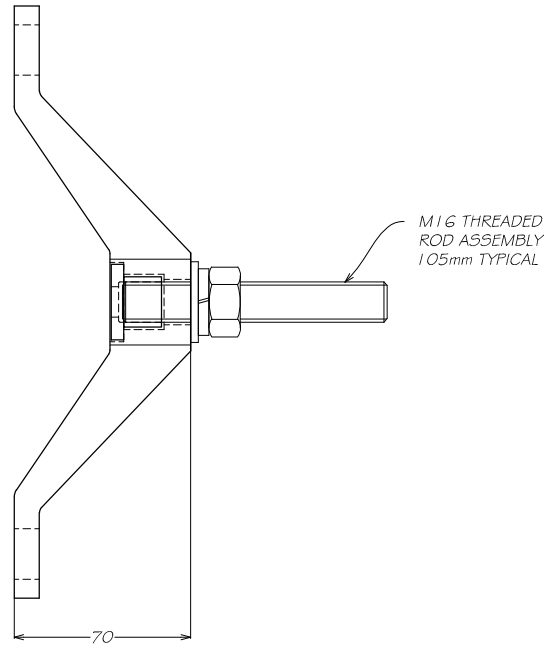

1
446-2 SPIDER
MASTER COPY
SCALE: 1:3

2 TYPICAL FIXING OPTIONS
SCALE: NTS

M10 CSK SCREW

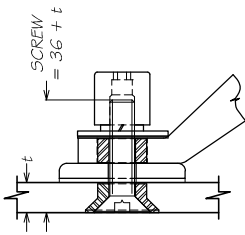

- M10 AGA NUT
- M10 SPRING WASHER
- 30 x 2 x M10 FLAT WASHER
- 30 x 0.8 x M10 FIBRE GASKET
- 19.5 x 10.5 x 9.5 BUSH FOR SPIDER PALM
- 446 SPIDER PALM
- 50 x 6mm DISC
- 50 x 10.5 x 0.8 FIBRE GASKET
- M10 CSK BUSH, TO SUIT GLASS THICKNESS

M10 CSK SCREW - WITH RA DISC

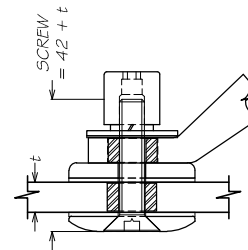

- M10 AGA NUT
- M10 SPRING WASHER
- 30 x 2 x M10 FLAT WASHER
- 30 x 0.8 x M10 FIBRE GASKET
- 19.5 x 10.5 x 9.5 BUSH FOR SPIDER PALM
- 446 SPIDER PALM
- 50 x 6mm DISC
- 50 x 10.5 x 0.8 FIBRE GASKET
- 19.5 x 10.5 BUSH, TO SUIT GLASS THICKNESS
- 50 x 10.5 x 0.8 FIBRE GASKET
- 50 x 6 x M10 RA DISC

HOLE DETAILS FOR TOUGHENED GLASS

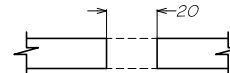
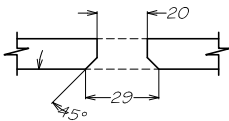

HOLE DETAILS FOR TOUGHENED LAMINATED GLASS
(THESE ARE PROJECT SPECIFIC. REFER TO MFG FOR DETAILS)

AUSTVISION



METRO FRAMELESS GLASS SYSTEMS
Unit 0/35 Maurice Road, Penrose, Auckland
PO Box 112 186, Penrose, Auckland
P: +64 9 622 2643
F: +64 9 622 2648
www.metroglasstech.co.nz

446 SPIDER SERIES
CATALOGUE DRAWING
446-2
WITH SCREW FIXINGS

Architect: -
Contractor: -

JLS:	REV	ISSUED	OWN BY	CHKD	DESCRIPTION
JLS:	A	02/05/14	RS	WF	ISSUED FOR CATALOGUE
Scale:	1:3	-	-	-	-
Draw No.:	01	-	-	-	-

THIS DOCUMENT IS THE PROPERTY OF METRO GLASSTECH. IT MUST NOT BE COPIED NOR THE CONTENTS PASSED ON TO ANY THIRD PARTY WITHOUT THE CONSENT OF THE COMPANY.

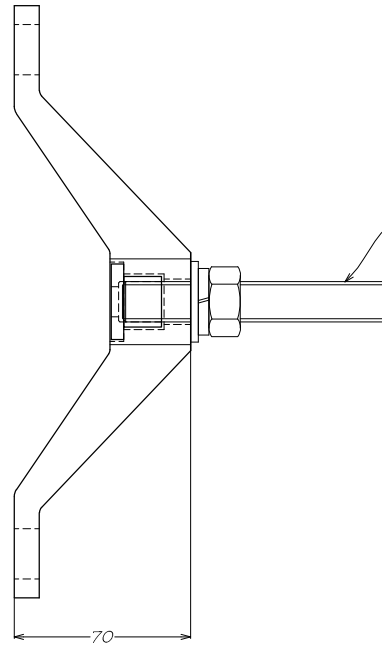
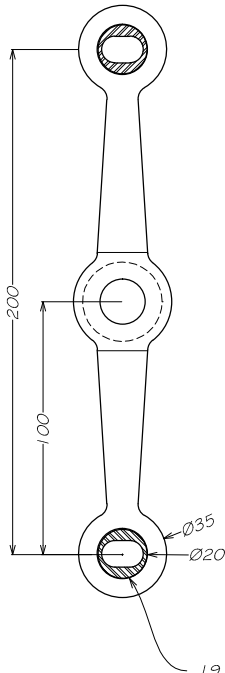
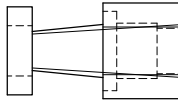

M16 THREADED
ROD ASSEMBLY
105mm TYPICAL

19.5 x M10 SLOT BUSH
(FOR M10 SCREWS ONLY)

19.5 x M14 BUSH FOR
SWIVEL HEAD

1
446-2 SPIDER
MASTER COPY
SCALE: 1:3

2
TYPICAL FIXING OPTIONS
CONTINUED
SCALE: NTS

32/22-22n SWIVEL

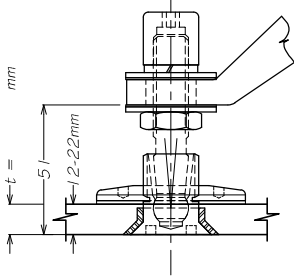

- M14 AGA NUT
- M14 SPRING WASHER
- 35 x 2 x M14 FLAT WASHER
- 35 x 0.8 x M14 FIBRE GASKET
- 19.5 x 14.5 x 9.5 BUSH FOR SPIDER PALM
- 446 SPIDER PALM
- 35 x 0.8 x M14 FIBRE GASKET
- 35 x 2 x M14 FLAT WASHER
- M14 NUT
- 32/22/22n SPIDER FITTING, INCLUDES BUSH TO SUIT GLASS THICKNESS

60/22-22n SWIVEL

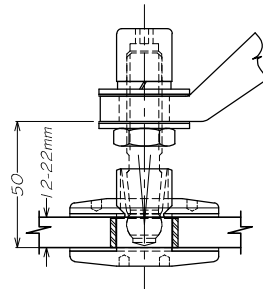

- M14 AGA NUT
- M14 SPRING WASHER
- 35 x 2 x M14 FLAT WASHER
- 35 x 0.8 x M14 FIBRE GASKET
- 19.5 x 14.5 x 9.5 BUSH FOR SPIDER PALM
- 446 SPIDER PALM
- 35 x 0.8 x M14 FIBRE GASKET
- 35 x 2 x M14 FLAT WASHER
- M14 NUT
- 60/22/22n SPIDER FITTING, INCLUDES BUSH TO SUIT GLASS THICKNESS

60/22-42n SWIVEL

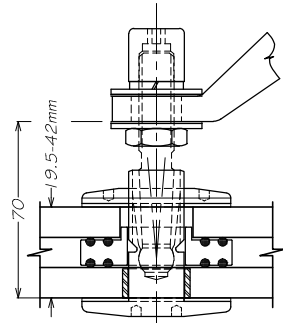

- M14 AGA NUT
- M14 SPRING WASHER
- 35 x 2 x M14 FLAT WASHER
- 35 x 0.8 x M14 FIBRE GASKET
- 19.5 x 14.5 x 9.5 BUSH FOR SPIDER PALM
- 446 SPIDER PALM
- 35 x 0.8 x M14 FIBRE GASKET
- 35 x 2 x M14 FLAT WASHER
- M14 NUT
- 60/22/42n SPIDER FITTING, INCLUDES BUSH TO SUIT GLASS THICKNESS
- IGU SPACER - 60 x 12mm DISC/ 60 x 1/2" DISC

HOLE DETAILS FOR TOUGHENED GLASS

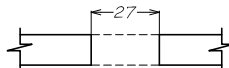
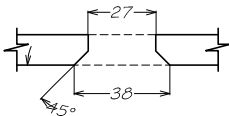

HOLE DETAILS FOR TOUGHENED LAMINATED GLASS
(THESE ARE PROJECT SPECIFIC. REFER TO MFG FOR DETAILS)

HOLE DETAILS FOR INSULATED GLASS

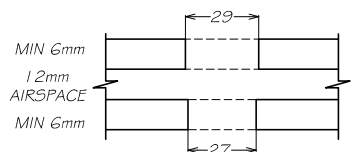

AUSTVISION



METRO FRAMELESS GLASS SYSTEMS
Unit 0/35 Maurice Road, Penrose, Auckland
PO Box 112 186, Penrose, Auckland
P: +64 9 622 2643
F: +64 9 622 2648
www.metroglasstech.co.nz

446 SPIDER SERIES
CATALOGUE DRAWING
446-2
WITH SWIVEL FIXINGS

Architect: -
Contractor: -

REV	ISSUED	OWN BY	CHKD	DESCRIPTION	
1	A	0205/14	RS	WF	ISSUED FOR CATALOGUE
Scale:	1:3				
Dwg No.:	01				

THIS DOCUMENT IS THE PROPERTY OF METRO GLASSTECH. IT MUST NOT BE COPIED NOR THE CONTENTS PASSED ON TO ANY THIRD PARTY WITHOUT THE CONSENT OF THE COMPANY.